

direct operated solenoid valves

coil 31 mm

general information	
ambient temperature	- 10°C to + 50°C
response time	6 - 18 ms
mounting	in any position
standard seal materials*	NBR, FPM, EPDM, BT4
dimensions	see page 2/2
coil data	see page 2/2
connector data	see page 2/2

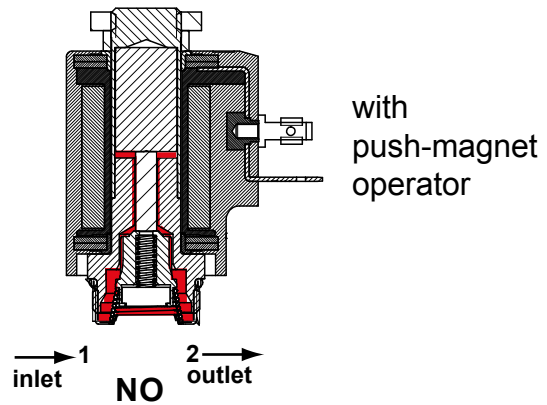

\* other seal materials on request

function	symbol	orif. mm	*Kv	pressure range (bar)			nominal power		TABLE A main code	
				min.	max. DC	max. AC	Watt DC	V.A. AC		
								inr.		hol
<b>2/2 normally open (NO)</b> 	0.8	0.5	0	-	60	-	21.5	13.5	<b>Q60208</b>	
	0.8	0.5	0	60	-	10	-	-	<b>Q60708</b>	
	1.2	1.3	0	-	45	-	21.5	13.5	<b>Q60212</b>	
	1.2	1.3	0	45	-	10	-	-	<b>Q60712</b>	
	1.6	1.7	0	-	25	-	21.5	13.5	<b>Q60216</b>	
	1.6	1.7	0	25	-	10	-	-	<b>Q60716</b>	
	2.0	3.0	0	-	16	-	21.5	13.5	<b>Q60220</b>	
	2.0	3.0	0	16	-	10	-	-	<b>Q60720</b>	
	2.4	3.5	0	-	10	-	21.5	13.5	<b>Q60224</b>	
	2.4	3.5	0	10	-	10	-	-	<b>Q60724</b>	
	3.0	4.5	0	-	7	-	21.5	13.5	<b>Q60230</b>	
	3.0	4.5	0	7	-	10	-	-	<b>Q60730</b>	
	4.0	7.5	0	-	3.5	-	21.5	13.5	<b>Q60240</b>	
	4.0	7.5	0	3.5	-	10	-	-	<b>Q60740</b>	

\*l/min. of water with ΔP of 1 bar

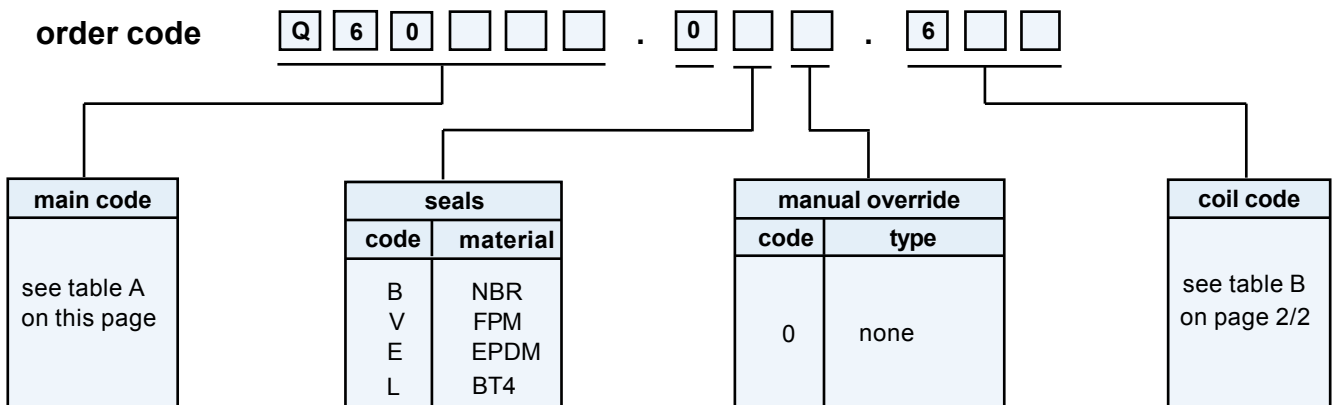

**FLO CONTROL**

Solenoid Valves



direct operated solenoid valves

coil 31 mm

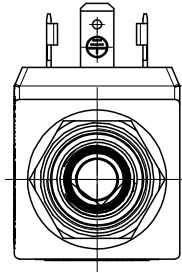

with  
push-magnet  
operator

Terminals for connector DIN 43650-A/ISO 4400

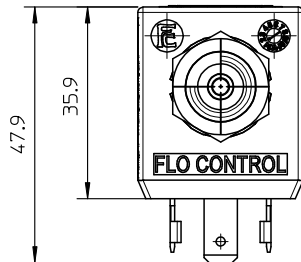
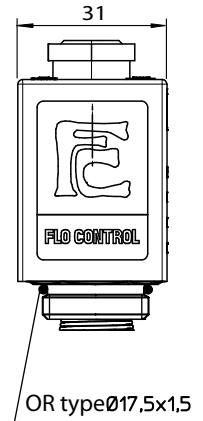
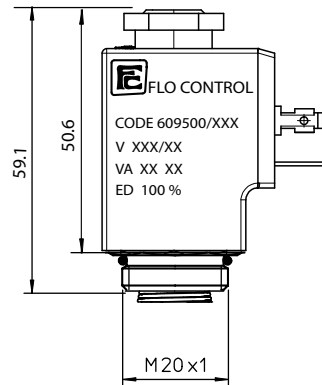
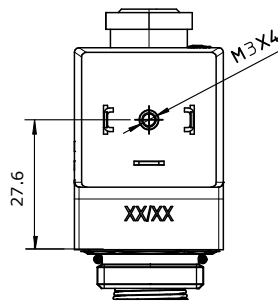
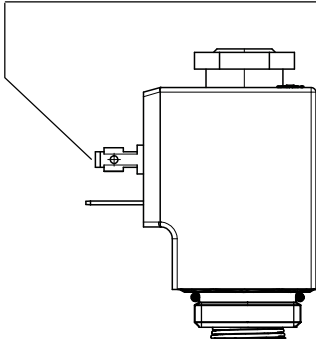

base machining  
data on request

weight 165 g

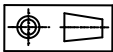

coil code	TABLE B			
	*voltages	code		
		~ 50 Hz	~ 60 Hz	= DC
12	-	-	666	
24	611	644	671	
48	616	-	676	
110	621	-	681	
115	-	653	-	
220	631	-	-	
230	638	659	-	
380	640	-	-	

coil specification	
wire insulation	class H180° C
encapsulation	class F155° C
encapsulation mat.	nylon
energising duration	100% at +20° C ambient
voltage tolerance	- 10% +15% of nominal voltage
*power consumption	AC 13,5 VA - DC 10 Watt
electrical connection	DIN 43650/A (2P+ earth)
cable connection	Pg 9 (for cable dia. 6-8mm)
protection class	IP 65 (with connector )

\* other voltages and wattages on request

connector (not included, must be ordered separately)

code Z10031

**FLO CONTROL**

Solenoid Valves

